

Amateur Radio Digital Open Protocol (ARDOP) Specification

Prepared by Rick Muething, KN6KB

Revision 0.7 July 1, 2015

1.0 Overview:

1.1 This document is a work in process design document that describes the Amateur Radio Digital Open Protocol (ARDOP). This document will be expanded and modified as the development effort continues and will become the complete public specification for the protocol. The specification and the protocol will be released to the public domain. Readers that have questions or comments about the spec or the protocol use are encouraged to contact the author at: rmuething@cfl.rr.com

2.0 Project Target Objectives:

2.1 The ARDOP is based loosely on and inspired by the popular WINMOR (Winlink Message Over Radio) protocol by Rick Muething, KN6KB. Though it has some similarities to WINMOR it is not intended to be compatible with or to communicate with the WINMOR protocol. That requirement would likely dramatically compromise the performance and complicate the development of the ARDOP.

2.2 Bandwidth: The protocol is intended to operate in one of four audio bandwidths, 200 Hz, 500 Hz, 1000 Hz, and 2000 Hz as measured at the -26 dB points of the transmitted spectrum. There are three methods two connecting stations can establish the session bandwidth:

- a) Forced by Client (the station sending the connect request)
- b) Forced by Server (the station receiving the connect request)
- c) Negotiated by the lower of Server or Client maximum bandwidth setting.

The Client or Server will have the ability to reject a connection request that is not bandwidth compatible or when the server detects prior signals in the passband (Listen before Transmit or Busy Detector). This insures minimal interference to existing connections and conformance to local applicable bandwidth rules for spectrum segments. In FEC (broadcast or multicast) mode any of the 4 bandwidths and any of the data frames can be used allowing tradeoff in bandwidth, robustness and throughput. ARQ sessions may use any data mode that is equal to or less than the session bandwidth. This permits dropping down to lower bandwidth modes for improved robustness or reduced interference.

2.3 Speed – Robustness Agility: The ARDOP ARQ protocol is intended to be able to automatically operate over a wide range of channel types, data rate and robustness levels. It should adapt to propagation seeking the best nominal modulation (and bandwidth in some cases) to maximize *net* error-free throughput. This is optimized by ACK/NAK back channel frames that communicate the received signal's average decoded symbol constellation quality back to the data sending station. The range in net (after

FEC) throughput will be in excess of 55:1 (slowest and most robust 200 Hz mode to fastest and least robust 2000 Hz mode)

- 2.4 Minimum Crest Factor: The protocol uses modulation types and techniques to minimize the crest factor (Peak to RMS Power). The nominal crest factor will range from 1.5 to 3.5 (a pure sine wave has a Peak to Average or crest factor of 1.41). This will maximize transmitted energy from a transmitter limited to a max PEP rating (most amateur SSB transmitters)
- 2.5 Compliance with US FCC Symbol rate rule: The maximum symbol rate on any carrier of SSB HF modes shall be 300 baud or less (Currently 25, 50, 100 and 167 baud). This is in conformance to the current US FCC rules. The protocol uses higher baud rates (currently 600 baud) for FM operation above 29 MHz. Additional modes for higher speed VHF/UHF using baud rates > 600 Hz may be added.
- 2.6 Strong Resistance to Multipath propagation: The protocol shall use techniques (low symbol rates, OFDM carriers with cyclic prefix, FSK, path compensation, etc. to optimize performance under poor multipath conditions (path delay variation up to 5 ms).
- 2.7 To minimize the chance of interference with other existing usage of a frequency the implementation includes features such as listen before transmit and busy detectors and the ability to reject connections or change bandwidths if channels are detected busy.
- 2.8 Implementation: It is anticipated there will be several implementations compatible with a number of platforms. These will include:
 - 2.8.1 Software implementations (virtual TNC with “sound card”) on Windows, Linux, Apple, and Android (with Parallels, Bootcamp, or VM Ware if needed) . These would also integrate easily with newer radios with built in sound cards. Windows and Linux versions currently in testing.
 - 2.8.2 Dedicated single chip CPUs or DSPs. DSP implementation will be chosen to minimize the demand for extensive storage buffers and high speed floating point.
- 2.9 Operating Modes and Radios: The protocol is intended for HF SSB and VHF/UHF both SSB and FM. Timing parameters cover extended range to accommodate these mode as well as SDR (Software Defined Radios e.g. Flex) .
- 2.10 Automatic Timing Setup: The protocol can operate in FEC (broadcast or multicast) or ARQ (connected) mode with automatic timing setup. This feature allows the automatic setup of frame and leader timing to cover alternate keying methods and Software Defined Radio timing and insures automatic timing adjustment for near optimum throughput. This automatic timing also permits using carrier or sub tone keyed repeaters (e.g. voice repeaters) on VHF/UHF. This however should only be done when coordinated with the local repeater management group.

3.0 Compatibility:

This specification does not cover the mechanism used to implement the ARDOP. This could be either a “virtual TNC” software/sound card implementation running under one of several operating systems and platforms or a dedicated CPU/DSP chip implementation containing its own sound card. However to insure interoperability between implementations it is required

that each implementation that identifies itself as “ARDOP compatible or compliant” successfully complete and document a compatibility/conformance test that covers the primary operating modes of the protocol. This mechanism for this test will be documented in separate document. It is recommended but not required that software or firmware implementations of the ARDOP be released as open source (*need definition of specific open source license mechanism here*) however modifications to the open source software **MUST** successfully pass the compatibility test to be able to claim they are ARDOP compliant.

4.0 Equipment Compatibility:

- 4.1 Frequency accuracy. The protocol shall accept a connection request where the Client and server frequencies are offset by up to 200 Hz for HF and VHF/UHF SSB modes . Frequency stability. The short term frequency stability of the transmitter and receiver shall be less than 1 Hz/second for SSB operation. Operation at worse frequency accuracy and stability will be possible with FM modes e.g. VHF/UHF FM.
- 4.2 Sound Card Compatibility: The protocol shall be compatible with the majority of common PC sound cards and radios with built-in sound cards (e.g. Icom 7100, 7200, 7600, 9100 and Kenwood TS-590S). A sound card sampling rate offset from nominal of +/- 1000 ppm shall be accommodated but may result in some performance degradation. The preferred sample rate offset shall be +/-100 ppm. The sampling rate selected shall be as low as possible (currently 12000 samples/sec) to provide good performance with minimum CPU demand and consistent with the common “cardinal” sound card rates (12000, 48000, or 96000 samples per second).
- 4.3 Software Defined Radios. The protocol will support manual or automatic leader and trailer timing modification to accommodate latency generally found in common SDR type radios (e.g. Flex radios or SDRs employing Virtual Audio Cables).
- 4.4 The protocol shall support all popular digital keying modes. This includes: transmitter “CAT” PTT control, dedicated serial port control (using RTS or DTR levels), conventional VOX control, and SignalLink or Rigblaster Advantage type integrated sound card VOX interfaces. The automatic timing mechanism will handle reasonable (up to 300 ms) VOX release delays but at some degradation in net throughput.
- 4.5 The protocol shall include features to automatically accommodate reasonable variations in round trip timing, operating system latency, and keying latency. These are adjusted automatically where possible or via an ini (setup parameter) file if necessary.
- 4.6 Host Interface. The ARDOP modem/TNC is intended to be a software/firmware implementation of a hard ware modem. It is intended to interface to the Host program using either a TCPIP connection (CPU local or wired/wireless to local network or remote location over the internet), Serial (RS-232 or USB) or Bluetooth (>= 19K baud). Details of the host interface are in a separate Interface document.

5.0 Operating Modes:

- 5.1 For error free data transmission the protocol will normally operate in an ARQ (Automatic Retry reQuest) mode where *TWO* stations are connected. The stations will operate ARQ where each data frame from the Information Sending station (ISS) is

acknowledged by the Information Receiving Station (IRS). In a normal forwarding session the rolls of IRS and ISS will be exchanged several times. The acknowledgement transmission (ACK or NAK) from the IRS will include information on the received signal average decoded symbol quality to aid the ISS in optimizing the modulation mode for maximum net (after repeats and corrections) throughput. An ARQ connection will use a session ID which helps “insulate” a connected session from any adjacent on-going ARQ session. Specific ARQ session rules and state diagram are included in Appendix D.

- 5.2 An alternate FEC operating mode is provided for robust “broadcast” or “multicast” capability for the transmission to many simultaneous listeners. Since there is no “back channel” such a FEC broadcast mode cannot be guaranteed to be error free but may be of value in some applications. The FEC broadcast mode allows for the broadcaster to adjust the robustness level of the transmission (bandwidth, modulation mode, and number of FEC frame repeats). FEC Protocol rules and state diagram is detailed in Appendix D.
- 5.3 The protocol (ARQ or FEC) can be “monitored” by a non-connected station but since there is no mechanism for a monitoring station to request a retransmission of a missed frame there may be “holes” or errors in the monitored data.

6.0 Operating Bandwidth:

- 6.1 The protocol uses a mechanism to allow both forced and negotiated session bandwidth between the Client and Server. This permits Servers (often unmanned) to be able to restrict bandwidth when necessary to conform to country or regional rules or to minimize chances for interference.
- 6.2 The 200 Hz single carrier mode is intended to be primarily used for keyboarding, SMS and lower speed (up to 210 words per minute with uncompressed text) message or small file exchange. It is however compatible with and may be used in conjunction with the higher bandwidth modes.
- 6.3 The ARQ connection mechanism used automatically establishes the connected session bandwidth. Each station sets a bandwidth parameter in its setup that defines either the max bandwidth or the forced bandwidth (200Hz, 500Hz, 1000Hz, or 2000Hz). The client station initiates the session with a connect request for its selected bandwidth. Appendix D describes the specific rules and mechanism the calling and target stations use to negotiate a compatible bandwidth or end a session if no compatible bandwidth is available.

7.0.1 Frame Types: (See appendix B for details)

- 7.1 Up to 256 frame types may be defined. ACK and NAK frame types include a small data field (5 bits) to indicate the decode quality of the received data frame. Therefore each ACK and NAK frame code uses 32 allocations of the 256. Every frame shall contain as a minimum: Tuning leader for all bandwidths consisting of a two tone signal (1450 and 1550 Hz) used for robustness and provides a mechanism for DSP tuning to within approximately 1 Hz. The two tone leader

provides a DSP mechanism to establish initial symbol sync based on the envelope correlation of the two tone waveform.

7.2 Frame Sync is a single symbol of the leader with reversed phase (e.g. non alternating phase of 1500 Hz).

7.2.1 After the frame sync each frame will contain 10 50 baud 4FSK symbols using a single active carrier. The 10 symbols encode 2 bytes + 2 parity symbols. The first byte is the frame type and the second byte is the frame type XORed with an 8 Bit Session ID. The session ID is derived from a CRC hash of the two connected call signs. When sending FEC (broadcast) data and some ARQ frame types the session ID will be forced to Hex FF. This provides the ability for non-connected stations to more easily monitor these frames. The 4FSK decoding of the frame type bytes uses minimal distance soft decoding for improved robustness.

7.3 Frame Type Basic Description (specific encoding in Appendix B)

7.3.1 Connect Request. (CONREQ200M, CONREQ500M, CONREQ1000M, CONREQ2000M, CONREQ200F, CONREQ500F, CONREQ1000F, CONREQ2000F) Includes additional data to include the call signs (up to 7 characters + optional –SSID of “-1” through “-15” and “-A” through “-Z”) of the originating and target stations and the Requested bandwidth (200, 500, 1000, 2000 Hz). This frame always uses a session ID of Hex FF. The two call signs are used by the receiving station to determine the specific session ID using an 8 bit CRC hash of both call signs. The 8 bit session ID will be used in computing the second Frame ID byte of all connected data and ACK/NAK frames to provide a measure of insulation against cross session ACK/Data contamination. (Two or more sessions operating on or near the same frequency).

7.3.2 Short Control frames: (typically 360 ms total length) All of these included the embedded session ID XORed with the frame type as the second frame type byte to reduce the chance of cross connection contamination.

7.3.2.1 DATANAK Frame received by the IRS when the ID and frame type decoded correctly but failure of data CRC after all FEC. Up to 5 bits of Decode quality information included in the DATANAK (uses up 32 of available 256 frame types). If the frame type and ID were NOT decoded correctly from the ISS there is *no reply* from the IRS. The quality reported ranges from 38 to 100 in steps of 2. A Quality value of 60 or above is typically required for practical decoding.

7.3.2.2 DATAACK Frame received by the IRS when the Frame type and ID and *all* frame data was correctly decoded. Up to 5 bits of decode quality information included in the DATAACK (uses up 32 of available 256 frame types). Decode quality in the ACK indicates to the ISS if faster or more robust modes would be more optimum. The quality reported ranges from 38 to 100 in steps of 2. A Quality value of 60 or above is normally required for decoding.

7.3.2.3 BREAK Used by the IRS to signal to the ISS the intent to take control of Link to become the new ISS.

7.3.2.4 END (Confirms End the session)

7.3.2.5 CONACK200 Connection Acknowledge. Session BW = 200 Hz. All CONACK frames contains a 1 byte data field (repeated 3 times for redundancy) which signals the sending station the

- received leader length (in 10's of ms). This is used to establish automatic timing parameters. (See appendix D Fig. D-1)
- 7.3.2.6 CONACK500 Connection Acknowledge. Session BW = 500 Hz
 - 7.3.2.7 CONACK1000 Connection Acknowledge. Session BW = 1000 Hz
 - 7.3.2.8 CONACK2000 Connection Acknowledge. Session BW = 2000 Hz
 - 7.3.2.9 CONREJBSY Connect Reject Busy. Reject connect request due to current activity detected on the channel. (Reduces potential interference in "hidden transmitter" conditions.)
 - 7.3.2.10 CONREJBW Connect Reject Bandwidth. Reject the connect request due to incompatible bandwidth settings. (e.g. Client has 500 Hz forced, Server has 2000 Hz forced)
 - 7.3.2.11 DISC. Disconnect Request. Signals a disconnect is desired. An answer with an END will terminate the Link. (See ARQ Protocol rules Appendix D)
 - 7.3.2.12 IDLE Used by the ISS to maintain link synchronization when there is no data to send. Usually precipitates the IRS to send data and become the new ISS in an automated forwarding session. (See ARQ protocol rules in Appendix D)
 - 7.3.2.13 IDFRAME Special frame to ID call sign and four, six, or eight character grid square of the sending station. Does not require acknowledgement and is ignored by a connected station (ARQ) or any monitoring station (FEC). Allows legal ID and can be monitored by non-connected stations. The ID frame is automatically inserted at least every 10 minutes by the current ISS. If the station sending the ID frame has CW ID enabled the ID frame will be followed by a CW call sign ID using FSK keying at 20 wpm or less.
 - 7.3.2.14 Data Frames: A number of data frames are provided which can be automatically selected by the ISS (based on the session bandwidth and decode quality received from the IRS) to adjust data speed, robustness and bandwidth. These may include some long (~ 4 seconds) and short (~2) seconds frames to optimize throughput and small packet turnaround (improved efficiency in keyboarding and message forwarding protocols). Detailed spread sheets in Appendix B identify these frames, their modulation mode, content, throughput and FEC mechanism. Any data frame may be sent in either ARQ (connected session) or FEC (broadcast/multicast) transmission.

8.0 Host Program interface

8.1 The ARDOP TNC/Modem is intended to work with a host program much the same way as a physical TNC requires interfacing to a host or terminal program. This section outlines the basics of that Host TNC interface. (Actual Host commands/responses are supplied in a separate document)

8.1.1 Interface Protocol: The protocol will assume a computerized interface at the host end (no direct manual keyboard command). The protocol will be initiated by a connection request to the ARDOP TNC through either a TCP/IP, RS232 Serial, or Bluetooth link. The links may be wireless (e.g. WiFi, Bluetooth etc.). The protocol for the Host interface shall be a combination of command response/acknowledge commands and asynchronous data transfers. These are be detailed in a separate host interface document.

- 8.1.2** Interface Security. The installation of the ARDOP TNC shall indicate the following in either a basic set up menu or command line launch argument.
- 8.1.2.1.1** Interface Type used TCPIP, Serial RS232, or BlueTooth Link
 - 8.1.2.1.2** TCPIP Address and port number or COM Port and Baud rate or BlueTooth pairing used
 - 8.1.2.1.3** Flag indicating whether secure Host connection is desired (normally used only with remote TCPIP connections)
 - 8.1.2.1.4** Password if secure Host connection is used.
 - 8.1.2.1.5** Once the host login is accomplished the host can change most operating and setup parameters except the Host interface parameters.
 - 8.1.2.1.6** Fail safe mechanism will be provided at the Host interface to insure the radio link is disconnected and the transmitter set to receive upon any loss of the Host interface.

9.0 Optional Radio Interface

- 9.1** Since the ARDOP TNC will normally have a close physical proximity to the transmitter and because some Transmitter control functions (e.g. PTT on/off) are time-critical to ARQ protocols an optional radio interface may be provided in the ARDOP TNC/Modem. The Host program can still implement radio control by itself or via other third party radio control software but some transmitter keying mechanisms (e.g. CAT PTT keying) may not be appropriate in some installations due to timing considerations.
- 9.2** In remote installations where the Host program may be remote from the ARDOP TNC/Modem radio control by the TNC/modem is the preferred mechanism. The ARDOP modem can be set up to interface (serial RS232 or USB serial) to control the radio including Frequency control, filter control, PTT on/off control and Aux mux control by those radios using integrated sound cards. (Kenwood TS-590S, Icom 7100, 7200, 7600, 9100). The initial ARDOP implementation will try to include support for most amateur and marine radios.

Appendix A: Revision History

This contains a brief revision history to changes made in the specification including its appendices.

Revision 0.1.7 May 17, 2014, Rick Muething, KN6KB

Added 200 Hz mode to specification. Eliminated ACKEVEN and ACKODD replaced with DATAACK

Modified Appendix B Detailed Frame Description. Added reference to and placeholder Appendix D Host interface.

Moved ARDOP Conformance Requirements to Appendix E.(place holder)

Revision 0.1.8 May 29, 2014, Rick Muething, KN6KB

Modified Operating Bandwidth and Frame Type sections. Updated worksheets in Appendix C.

Added sections 8 Host Program Interface and 9 Optional Radio Interface

Update of Appendices B and C

Revision 0.1.9 June 5, 2014, Rick Muething, KN6KB

Modified Callsign fields to 7 characters + optional –SSID of “-1” through “-Z”. This shortens the Connect Request frame and ID frame to typically 1040 ms.

Revision 0.1.10 June 12, 2014, Rick Muething, KN6KB

Modified All frame type spread sheets (Appendix C) to show PSK modes at 100 and 167 effective baud rates. Removed frame types REQPSN, LASTPSNE, LASTPSN O ...not needed.

Revision 0.1.11 Nov 18, 2014, Rick Muething, KN6KB

Update bandwidth measurement to -26 dB point (was -30) in Section 2.2

Update speed/robustness range to 22 in Section 2.3

Clarification of Crest factor range in Section 2.4

Modify BlueTooth interface options in section 8

Eliminate serial and USB host interface options in Appendix D

Revision 0.1.12 Nov 26, 2014

Minor text corrections. Add Frame Type spread sheet to appendix B.

Revision 0.1.13 Dec 9, 2014

Change all 4PSK 72 data + 24 parity carriers to 64 data + 32 Parity. Same length and improved *net* throughput in all but very good channels. Update all mode spread sheets and spec Appendix C.

Fixed multi carrier per carrier reference phase initialization in EncodeModulate.ModPSK to always force 0 as reference (was $i \text{ Mod } 4$)

Revision 0.1.14 Jan 2, 2015

Make mods to Host interface allowing RS 232 connections as well as TCPIP and BlueTooth.

Revision 0.2.0. Feb 10, 2015

Addition of protocol Rules Appendix D. Modifications to frame type CONACK to include leader timing data. Elimination of OVER frame type. General cleanup of text and spread sheet in appendices B and C.

Revision 0.3.0. Mar 3, 2015

Addition of 4FSK robust data modes (50 and 100 baud), 200, 500, 1000, and 2000 Hz bandwidths.

Elimination of different frame types for ARQ and FEC modes.

Modification of all control frame details and codes and Data frame type bytes to use 4FSK 50 baud modulation.

Update of frame spread sheets. Appendices B and C.

Revision 0.3.1 Mar 25, 2015

Addition of Timing diagram D-1 to appendix D.

Revision 0.6 July 1, 2015 (Corresponds to the end of Alpha Testing)

Addition of details on FM modes.

Appendix B. Detailed Frame Description (preliminary)

This appendix contains a detailed description of all frames used in the ARDOP Protocol.

Definitions:

Leader (200Hz, 500Hz, 1000Hz, 2000Hz BW): A sequence of 10 ms symbols at 1500 Hz of alternating phase (0, 180 degrees. This is equivalent to each symbol containing a 10 ms burst of 1450 and 1550 Hz (Two tone) . The leader length may be from 10 symbols (100 ms) to 100 symbols (1000 ms) and must be an integral number of symbols. Normally auto timing (see Appendix diagram D-1) is used to allow both the IRS and ISS to automatically establish optimum leader length for the selected keying mechanism.

LeaderSync (All bandwidths): A single 10 ms symbol following the leader but without phase inversion. (two adjacent symbols with the same phase @ 1500 Hz)

FrameType (All bandwidths): A single byte (four 50 baud 4FSK symbols) indicating the 8 bit frame type. (see Frame Type Table) The frame type byte is repeated (4 additional symbols) as the Frame type exclusive ored with the Session ID byte (Hex FF for unconnected frames) . Two parity symbols are added for improved decoding distance. Each specific frame type defines the modulation type, data encoding and the total number of symbols in the frame.

FrameData: The frame data consists of 1 or more simultaneous carriers. For PSK modes each carrier begins with a one symbol reference phase. For 4FSK modes no reference symbol is needed. Data frames contain 1 byte (8 bits) of byte count (per carrier) and a 16 bit CRC (CRC16 Polynomial: $x^{16} + x^{12} + x^5 + 1$) of the carrier data + carrier byte count. The CRC calculation does *NOT* include any FEC added for error correction. Unused data bytes in the data field are zero filled. On high baud rate (> 600 baud) FM modes multiple sequential packets (with byte count, data, CRC and RS FEC) are concatenated.

Appendix B: Frame Type Table and Codes

Amateur Radio Digital Open Protocol (ARDOP) Frame Definitions and Codes (Rev 6/27/2015)										
Frame Type	Modulation Type	Code Range (Hex)	Overhead (ms) ¹	Payload (Bytes) ²	car (Bytes) ³	Net Payload (bytes) ⁵	Frame Len (ms) ²	Frame ID	Notes/Comments	
DATANAK w Quality	1 Car, 4FSK, 50 Bd	00-1F	0	2	0	0	2	200 SESSIONID	5 LS bits indicate decode quality (0-31)	
BREAK	1 Car, 4FSK, 50 Bd	23	0	2	0	0	2	200 SESSIONID		
END	1 Car, 4FSK, 50 Bd	2C	0	2	0	0	2	200 SESSIONID		
DISC	1 Car, 4FSK, 50 Bd	29	0	2	0	0	2	200 SESSIONID		
IDLE	1 Car, 4FSK, 50 Bd	26	0	2	0	0	2	200 SESSIONID		
CONREJBUSY	1 Car, 4FSK, 50 Bd	2D	0	2	0	0	2	200 SESSIONID		
CONREJBW	1 Car, 4FSK, 50 Bd	2E	0	2	0	0	2	200 SESSIONID		
IDFRAME's	1 Car, 4FSK, 100 Bd, RS FEC	30	160	12	2	2	14	1320 FF	Payload = call sign + 14, 6 or 8 char Grid square	
CONREQ2000's	1 Car, 4FSK, 100 Bd, RS FEC	31	160	12	2	2	14	1320 FF	Includes Caller and Target call signs	
CONREQ3000's	1 Car, 4FSK, 100 Bd, RS FEC	32	160	12	2	2	14	1320 FF	Includes Caller and Target call signs	
CONREQ1000M's	1 Car, 4FSK, 100 Bd, RS FEC	33	160	12	2	2	14	1320 FF	Includes Caller and Target call signs	
CONREQ2000M's	1 Car, 4FSK, 100 Bd, RS FEC	34	160	12	2	2	14	1320 FF	Includes Caller and Target call signs	
CONREQ200F's	1 Car, 4FSK, 100 Bd, RS FEC	35	160	12	2	2	14	1320 FF	Includes Caller and Target call signs	
CONREQ300F's	1 Car, 4FSK, 100 Bd, RS FEC	36	160	12	2	2	14	1320 FF	Includes Caller and Target call signs	
CONREQ1000F's	1 Car, 4FSK, 100 Bd, RS FEC	37	160	12	2	2	14	1320 FF	Includes Caller and Target call signs	
CONREQ2000F's	1 Car, 4FSK, 100 Bd, RS FEC	38	160	12	2	2	14	1320 FF	Includes Caller and Target call signs	
CONACK200 + timing 6	1 Car, 4FSK, 100 Bd	39	160	3	0	0	3	440 SESSIONID	Includes Received Leader timing	
CONACK500 + timing 6	1 Car, 4FSK, 100 Bd	3A	160	3	0	0	3	440 SESSIONID	Includes Received Leader timing	
CONACK1000 + timing 6	1 Car, 4FSK, 100 Bd	3B	160	3	0	0	3	440 SESSIONID	Includes Received Leader timing	
CONACK2000 + timing 6	1 Car, 4FSK, 100 Bd	3C	160	3	0	0	3	440 SESSIONID	Includes Received Leader timing	
200 Hz Bandwidth Data:										
4FSK200.100E/O	4FSK 200Hz Long Even/Odd	40,41	160	65 32 + 2			64	4160 SESSIONID	Normal 4FSK Data 100 bd (64 byte payload)	
4FSK200.100S E/O	4FSK 200Hz Short Even/Odd	42,43	160	17 8 + 2			16	1280 SESSIONID	Short 4FSK Data 100 bd (16 byte payload)	
8FSK200.100E/O	8FSK 200Hz Long Even/Odd	44,45	160	109 36 + 2			108	4120 SESSIONID	High ThruPut 8FSK Data 100 bd (108 byte payload)	
4FSK200.50E/O	4FSK 200Hz Long Even/Odd	46,47	160	33 8 + 2			32	3640 SESSIONID	Robust 4FSK Data 50 bd (32 byte payload)	
4FSK200.50S E/O	4FSK 200Hz Short Even/Odd	48,49	160	17 4 + 2			16	2180 SESSIONID	Robust 4FSK Data 50 bd (16 byte payload)	
8FSK200.25E/O	8FSK 200Hz Long Even/Odd	4E,4F	160	25 6 + 2			24	3720 SESSIONID	Robust 8FSK Data 25 bd (24 byte payload)	
500 Hz Bandwidth Data:										
4FSK500.100E/O	4FSK 500Hz Long Even/Odd	50,51	160	65 32 + 2			128	4930 SESSIONID	Normal 4FSK Data 100 bd (128 byte payload)	
8FSK500.100E/O	8FSK 500Hz Long Even/Odd	52,53	160	109 36 + 2			216	4290 SESSIONID	High ThruPut 8FSK Data 100 bd (216 byte payload)	
4FSK500.167 E/O	4FSK 500Hz Long Even/Odd 167 baud	54, 55	200	121 40 + 2			240	4231 SESSIONID	High ThruPut 4FSK Data 167 bd (240 byte payload)	
8FSK500.167 E/O	8FSK 500Hz Long Even/Odd 167 baud	56, 57	200	160 60 + 2			318	3918 SESSIONID	High ThruPut 8FSK Data 167 bd (318 byte payload)	
4FSK500.100E/O	4FSK 500Hz Long Even/Odd	44,48	200	65 16+ 2			64	3520 SESSIONID	Robust 4FSK Data 100bd (64 byte payload)	
4FSK500.100S E/O	4FSK 500Hz Short Even/Odd	4C, 4D	200	33 8+ 2			32	1920 SESSIONID	Robust 4FSK Data 100bd (32 byte payload)	
16FSK500.25 E/O	16FSK 500Hz Long Even/Odd	58,59	200	33 8+ 2			32	3640 SESSIONID	Robust 16FSK Data 25 bd (32 byte payload)	
16FSK500.25S E/O	16FSK 500Hz Short Even/Odd	5A,5B	200	17 4 + 2			16	2040 SESSIONID	Robust 16FSK Data 25 bd (16 byte payload)	
1000 Hz Bandwidth Data:										
4FSK1000.100E/O	4FSK 1000Hz Long Even/Odd	60,61	200	65 32 + 2			256	4170 SESSIONID	Normal 4FSK Data 100 bd (256 byte payload)	
8FSK1000.100E/O	8FSK 1000Hz Long Even/Odd	62,63	200	109 36 + 2			432	4120 SESSIONID	High ThruPut 8FSK Data 100 bd (432 byte payload)	
4FSK1000.167 E/O	4FSK 1000Hz Long Even/Odd 167 baud	64, 65	200	121 40 + 2			480	4112 SESSIONID	High ThruPut 4FSK Data 167 bd (480 byte payload)	
8FSK1000.167 E/O	8FSK 1000Hz Long Even/Odd 167 baud	66, 67	200	160 60 + 2			636	3712 SESSIONID	High ThruPut 8FSK Data 167 bd (636 byte payload)	
4FSK1000.100E/O	4FSK 1000 Hz 2 car 4FSK Even/Odd 100 baud	68,69	200	65 16 42			128	3530 SESSIONID	Robust 4FSK with two Simultaneous carriers (128 byte Payload)	
2000 Hz Bandwidth Data:										
4FSK2000.100E/O	4FSK 2000Hz Long Even/Odd	70,71	200	65 32 + 2			512	4170 SESSIONID	Normal 4FSK Data 100 bd (512 byte payload)	
8FSK2000.100E/O	8FSK 2000Hz ARCQ Long Even/Odd	72,73	200	109 36 + 2			864	4120 SESSIONID	High ThruPut 8FSK Data 100 bd (864 byte payload)	
4FSK2000.167 E/O	4FSK 2000Hz Long Even/Odd 167 baud	74,75	200	121 40 + 2			960	4112 SESSIONID	High ThruPut 4FSK Data 167 bd (960 byte payload)	
8FSK2000.167 E/O	8FSK 2000Hz Long Even/Odd 167 baud	76,77	200	160 60 + 2			1272	3712 SESSIONID	High ThruPut 8FSK Data 167 bd (1272 byte payload)	
4FSK2000.100E/O	4FSK 2000 Hz 2 car 4FSK Even/Odd 100 baud	78,79	200	65 16 + 2			128	3930 SESSIONID	Robust 4FSK with four Simultaneous carriers (256 byte Payload)	
4FSK2000.600E/O	4FSK 2000 (4FSK 1 Active Carrier, 600 baud, with RS FEC)	7A,7B	200	600 4FSK			600	5100 SESSIONID	High Band 1 car 4FSK long (600 byte payload)	
4FSK2000.600S E/O	4FSK 2000 (4FSK short, 1 Active Carrier, 600 baud, with RS FEC)	7C,7D	200	200 4FSK			200	1727 SESSIONID	High Band 1 car 4FSK short (200 byte payload)	
4FSK2000.1000E/O	4FSK 2000 (1 Active Carrier, 1000 baud, With RS)	80,81	200	800 4FSK			800	4468 SESSIONID	High Band 1 car 4FSK long (800 byte payload)	
8FSK2000.1000E/O	8FSK 2000 (1 Active Carrier, 1000 baud, With RS)	82,83	200	1080 8FSK			1080	4280 SESSIONID	High Band 1 car 8FSK long (1080 byte payload)	
DATAACK w Quality	1 Car, 4FSK, 50 Bd	E0-FF	200	2	0	0	2	200 SESSIONID	5 LS bits indicate decode quality (0-31)	

Notes:
 1) Frame Type and Frame Type with Session ID and Parity (10 4FSK symbols of 20 ms)
 2) Excludes leader (length negotiated, typically 100-1000 ms) Does not include ACK/NAK and round trip latency on ARQ modes.
 3) Includes 1 byte Count/Carrier on data frames
 4) All Frame types in **BOLD** have had basic testing.
 5) Connect Request and ID Frame use call sign and grid square compression to 6 bytes each.
 6) Connect ACK frames include 1 byte timing info in 10's of ms (0-2550 ms)
 7) Frame types in **Bold** currently used in ARQ mode

Appendix C: Mode and Bandwidth Detailed Spreadsheets.

This appendix contains a detailed spread sheets (in process) showing details of each modulation mode for each bandwidth, the typical crest factor, maximum mode throughput, estimated Eb/No of each mode for the same bit error rate. Also included are the post Transmit filtered spectrums of typical modes.

ARDOP 200 Hz Bandwidth Worksheet										June 27, 2015	
Data Frames	Data Mode/Description	Effective Sym rate	# of Car	Cyclic Prefix or Guard	Mod	Typ Crest Factor 4	Payload (bytes)	Parity (bytes)	Frame Len (ms)	Max Thruput (bytes/min)	Raw Rate (Bits/sec/Hz)
4PSK200.100. E/O	4PSK200 Long (1 Car 100 baud Differential 4PSK with RS FEC)	100	1	1.3 ms CP	4PSK	1.62	64 RS 32	4320	756	1.00	
4PSK200.100S: E/O	4PSK200 Short (1 Car 100 baud Differential 4PSK with RS FEC)	100	1	1.3 ms CP	4PSK	1.62	16 RS 8	1440	436	1.00	
8PSK200.100. E/O	8PSK200 Long (1 Car 100 baud Differential 8PSK with RS FEC)	100	1	1.3 ms CP	8PSK	1.62	108 RS 36	4280	1286	1.50	
4FSK200.50. E/O	4FSK Long (1 active carrier 50 baud 4FSK with RS FEC)	50	1	none	4FSK	1.5	32 RS 8	3800	500	0.50	
4FSK200.50S: E/O	4FSK Short (1 active carrier 50 baud 4FSK with RS FEC)	50	1	none	4FSK	1.5	16 RS 4	2340	310	0.50	
8FSK200.25S: E/O	8FSK (1 active carrier 25 baud 8FSK with RS FEC)	25	1	none	8FSK	1.5	24	3880	310	0.25	
Non Data Frames	(used by all bandwidths)										
ARQ Short Control	Break, End, Disc, Idle, DataACK, DataNAK, CONRejBusy	50	1	none	4FSK	1.4	0	0	360 NA	0.50	
Connection Start	CONACK200, CONACK500, CONACK1000, CONACK2000	50	1	none	4FSK	1.4	3	0	600 NA	0.50	
ID Frame	CONReq200M/F, CONReq500M/F, CONReq1000M/F, CONReq2000M/F	50	1	none	4FSK	1.4	12.4 RS	1640 NA	1640 NA	0.50	
	IDFrame (call sign + 4 or 6 char Grid Square)				4FSK	1.4	12.4 RS	1640 NA	1640 NA	0.50	
	Note 1: Modes in BOLD type are currently being used in ARQ mode.										
	Note 2: ARQ Throughput calculation includes 160ms leader + 200ms ACK + 400ms total timing guard band. (divide by 6 to get uncompressed WPM)										
	Note 3: Includes typical 160ms Leader With Sync, 20 symbol Frame Type, ByteCnt, Payload, 16 bit CRC, RS Parity										
	Note 4: Crest factor is WaveForm Peak value to RMS value (pure sine wave is 1.41)										
	Note 5: Excluding leader, sync, RS and ARQ overheads.										
	Typical 1 Car 100 baud 4PSK spectrum after transmit filtering										
											
	Typical 1 Car 50 baud 4FSK spectrum after transmit filtering										
											

Fig C-1: 200 Hz Worksheet (200 Hz frames can be used in all bandwidths)

ARDOP 500 Hz Bandwidth Worksheet

Data Frames	Data Mode/Description	Effective Sym rate	# of Car	Cyclic Prefix or Guard	Mod	Typ Crest Factor	Payload (bytes/car)	Parity (bytes/car)	Frame Len (ms)	Max Thruput (bytes/min)	June 27, 2015	Raw
4PSK500.100.E/O	4PSK500 Long (2 Car 100 baud Differential 4PSK with RS FEC)	100.0	2	3 ms CP	4PSK	2.22	64 RS 32	4280	1509	0.80		
8PSK500.100.E/O	8PSK500 Long (2 Car 100 baud Differential 8PSK with RS FEC)	100.0	2	3 ms CP	8PSK	2.22	108 RS 36	4290	2566	1.20		
4PSK500.167.E/O	4PSK500 Long (2 Car 167 baud Differential 4PSK with RS FEC)	166.7	2	1 ms CP	4PSK	2.44	120 RS 40	4391	2796	1.33		
8PSK500.167.E/O	8PSK500 Long (2 Car 167 baud Differential 8PSK with RS FEC)	166.7	2	1 ms CP	8PSK	3.54	159 RS 60	3918	4079	2.00		
4FSK500.100.E/O	4FSK500.100.E/O (4FSK Long 100 baud with RS FEC)	100	1	none	4FSK	1.5	64 RS 16	3680	865	0.40		
4FSK500.100S.E/O	4FSK500.100S.E/O (4FSK Short 1 Active Carrier 100 baud with RS FEC)	100	1	none	4FSK	1.5	32 RS 8	1980	701	0.40		
16FSK500.25.E/O	16FSK500.25.E/O (16FSK 1 Active Carrier 25 baud with RS FEC)	25	1	none	16FSK	1.5	32 RS 8	3800	421	0.25		
16FSK500.25S.E/O	16FSK500.25S.E/O (16FSK Short 1 Active Carrier 25 baud with RS FEC)	25	1	none	16FSK	1.5	16 RS 4	2200	324	0.25		

Note 1: Modes in **BOLD** type are currently being used in ARQ mode.
 Note 2: ARQ Throughput calculation includes 160ms leader + 200 ms ACK + 400 ms total timing guard band. (divide by 6 to get uncompressed WPM)
 Note 3: Includes typical 160 ms Leader With Sync, 20 symbol Frame Type, ByteCnt, Payload, 16 bit CRC, RS Parity
 Note 4: Crest factor is WaveForm Peak value to RMS value (pure sine wave is 1.41)
 Note 5: Excluding Leader, sync, RS and ARQ overheads.

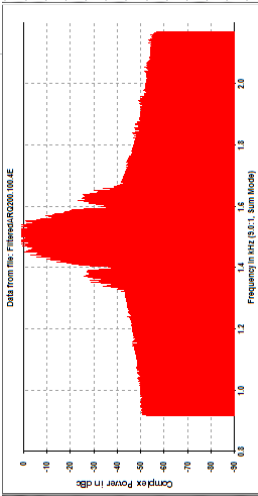
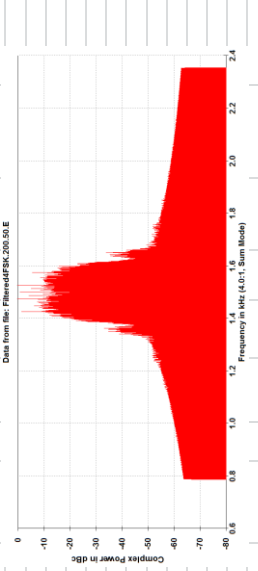
Typical 2 Car 100 baud 4PSK spectrum after transmit filtering

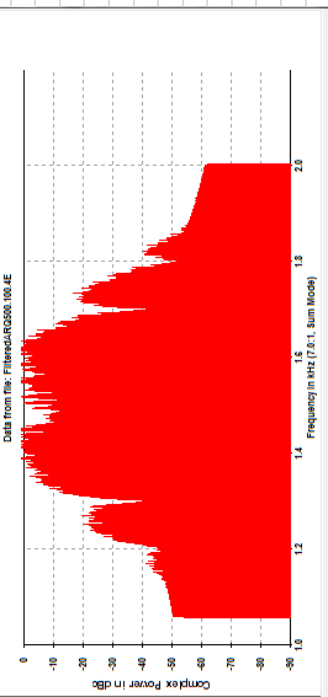

Typical 1 Car 100 baud 4FSK spectrum after transmit filtering

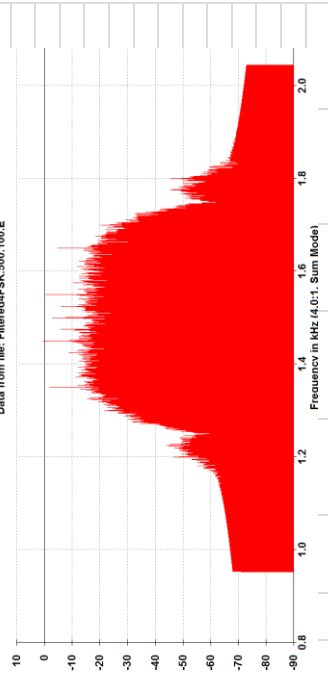

Fig C-2: 500 Hz Modes

ARDOP 1000 Hz Bandwidth Worksheet											
Data Frames	Data Mode/Description	Effective Sym rate	#of Car	Cyclic Prefix or Guard	Mod	Typ Crest Factor	Payload (bytes/car)	Parity (bytes/car)	Frame Len (ms)	Max Throughput (bytes/min)	June 27, 2015
											Raw
4PSK1000.100.E/O	4PSK1000 ARQ Long (4 Car 100 baud Differential 4PSK with RS FEC)	100	4	3 ms CP	4PSK	2.81	64 RS 32	4330	3018	0.80	
8PSK1000.100.E/O	8PSK1000 ARQ Long (4 Car 100 baud Differential 8PSK with RS FEC)	100	4	3 ms CP	8PSK	2.81	108 RS 36	4280	5133	1.20	
4PSK1000.167.E/O	4PSK1000 ARQ Long (4 Car 167 baud Differential 4PSK with RS FEC)	166.7	4	1 ms CP	4PSK	2.89	120 RS 40	3918	6156	1.33	
8PSK1000.167.E/O	8PSK1000 ARQ Long (4 Car 167 baud Differential 8PSK with RS FEC)	166.7	4	1 ms CP	8PSK	3.54	159 RS 60	3772	8420	2.00	
4FSK1000.100.E/O	4FSK1000 (4FSK Long, 2 Active Carriers, 100 baud with RS FEC)	100	2	none	4FSK	2.2	64 RS 16	3690	1726	0.40	
	Note 1: Modes in BOLD type above are used in ARQ mode.										
	Note 2: ARQ Throughput calculation includes 160 ms leader + ACK + 400 ms total timing guard band. FEC throughput calculation include 400 ms inter frame gap. (divide by 6 to get uncompressed WPN)										
	Note 3: Includes typical 160 ms Leader With Sync, 15 symbol Frame Type, ByteCnt, Payload, 16 bit CRC, RS Parity										
	Note 4: Crest factor is WaveForm Peak value to RMS value (pure sine wave is 1.41)										
	Note 5: Excluding Leader, sync, RS and ARQ overheads.										
	Typical 4 Car 100 baud 4PSK spectrum after transmit filtering										
	Typical 2 Car 100 baud 4FSK spectrum after transmit filtering										

Fig C-3: 1000 Hz Modes

ARDOP 2000 Hz Bandwidth Worksheet											June 27, 2015	
Data Frames	Data Mode/Description	Effective Sym rate	#of Car	Cyclic Prefix or Guard	Mod	Typ Crest Factor 4	Payload (bytes/car)	Parity (bytes/car)	Frame Len (ms)	Max Throughput (bytes/min)	Raw Bits/sec/Hz	
4PSK2000.100.E/O	4PSK2000 Long (8 Car 100 baud Differential 4PSK with RS FEC)	100	8	3 ms CP	4PSK	3.34	64 RS 32	64 RS 32	4280	6144	0.80	
8PSK2000.100.E/O	8PSK2000 Long (8 Car 100 baud Differential 8PSK with RS FEC)	100	8	3 ms CP	8PSK	3.34	108 RS 36	108 RS 36	4280	10386	1.20	
4PSK2000.167.E/O	4PSK2000 Long (8 Car 167 baud Differential 4PSK with RS FEC)	166.7	8	1 ms CP	4PSK	3.54	120 RS 40	120 RS 40	4232	11628	1.33	
8PSK2000.167.E/O	8PSK2000 Long (8 Car 167 baud Differential 8PSK with RS FEC)	166.7	8	1 ms CP	8PSK	3.54	159 RS 60	159 RS 60	3872	17220	2.00	
4FSK2000.100.SE/O	4FSK2000 (4FSK Short 4 Active Carriers, 100 baud, with RS FEC)	100	4	none	4FSK	2.6	64 RS 16	64 RS 16	2040	3524	0.40	
4FSK2000.100.SE/O	4FSK2000 (4FSK Long 4 Active Carriers, 100 baud, with RS FEC)	100	4	none	4FSK	2.6	64 RS 16	64 RS 16	3640	3524	0.40	
4FSK2000.600.E/O	4FSK2000 (4FSK 1 Active Carrier, 600 baud, with RS FEC)	600	1	none	4FSK	1.5	600 RS 150	600 RS 150	5260	5863	0.60	
4FSK2000.600S.E/O	4FSK2000 (4FSK short, 1 Active Carrier, 600 baud, with RS FEC)	600	1	none	4FSK	1.5	200 RS 50	200 RS 50	1887	4338	0.60	
4PSK2000.1000.E/O	4PSK2000 (1 Active Carrier, 1000 baud, With RS)	1000	1	166 uS CP	4PSK	1.5	800 RS 200	800 RS 200	4608	8942	1.00	
8PSK2000.1000.E/O	8PSK2000 (1 Active Carrier, 1000 baud, With RS)	1000	1	166 uS CP	8PSK	1.5	1080 RS 432	1080 RS 432	4440	12461	1.50	
<p>Note 1: Modes in BOLD type above are used in ARQ mode.</p> <p>Note 2: ARQ Throughput calculation includes 160 ms leader + ACK + 400 ms total timing guard band. FEC throughput calculation include 400 ms inter frame gap. (divide by 6 to get uncompressed WPN)</p> <p>Note 3: Includes typical 160 ms Leader With Sync, 20 symbol Frame Type, ByteCnt, Payload, 16 bit CRC, RS Parity (add ~720ms for ARQ cycle)</p> <p>Note 4: Crest factor is WaveForm Peak value to RMS value (pure sine wave is 1.41)</p> <p>Note 5: Excluding Leader, sync, RS and ARQ overheads.</p>												
<p>Typical 8 Car 100 baud 4PSK spectrum after transmit filtering</p> 												
<p>Typical 8 Car 167 baud 4PSK spectrum after transmit filtering</p> 												
<p>Typical 4 Car 100 baud 4FSK spectrum after transmit filtering</p> 												

Fig C-4: 2000 Hz Modes

Appendix D: Protocol Rules

This appendix contains the specific protocol rules and simplified state transition diagrams for ARDOP ARQ and FEC modes. These rules are referenced in comments in the protocol code and in the state diagrams to aid in understanding the protocol implementation.

ARQ CONNECTION/SESSION RULES:

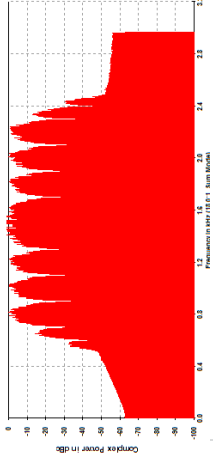
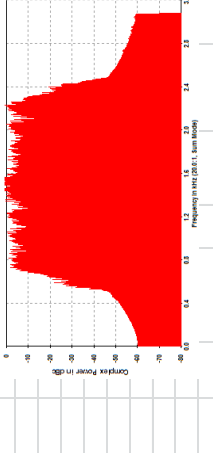
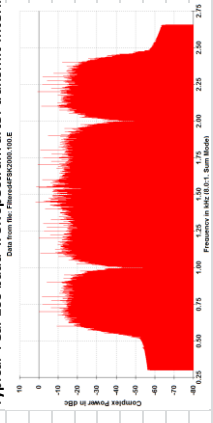
ARQ connections are between two stations. The stations currently sending data is the ISS or Information Sending Station. The station currently receiving data is the IRS or Information Receiving Station. In a typical session the rolls of IRS and ISS are exchanged multiple times. ARQ connected sessions insure error free and higher throughput data delivery due to the active reverse (ACK/NAK) channel of the IRS.

1.0 Establishing an ARQ Connection (Both IRS and ISS are assumed to be on line (“sound cards” sampling) and in the DISC state)

- 1.1 **ISS (station Calling or Client) sends a ConReq frame to a specific call sign for the desired session bandwidth (200,500,1000 or 2000Hz MAX or FIXED Bandwidth). ConReq is repeated until answered by a decoded ConAck from the station being called or timeout. (10-30 seconds)**
- 1.2 **If the IRS (station Receiving or Server) call sign matches that of the CONREQ and the IRS's bandwidth is compatible with he requested bandwidth the IRS sends a CONACK frame for the negotiated bandwidth. The ConAck contains one byte of timing information (repeated 3 times for redundancy) indicating the length (in tens of ms) of the received ISS leader. This allows the ISS to then optimize the leader length for reliability and max throughput (see Fig D-1).**
- 1.3 **If the IRS's bandwidth setting is not compatible with the ConReq received from the ISS the IRS Issues a ConRejBW frame and stays in the DISC connected state.**
- 1.4 **If the ISS receives a ConAck frame from the IRS (with received leader timing) it Sends a ConAck reply to the IRS with the received IRS Leader timing information This allows the IRS to optimize the leader length for reliability and max throughput. The IRS confirms reception of the ISS's ConAck with a standard ACK and the session is connected. Fig D-1 summarizes this mechanism. The total time for this call sign, bandwidth and timing exchange is typically 5 seconds but can be extended if repeats are required.**

ARQ Bandwidth Negotiation & Timing Exchange

Rev June 2, 2015
(Not to scale)

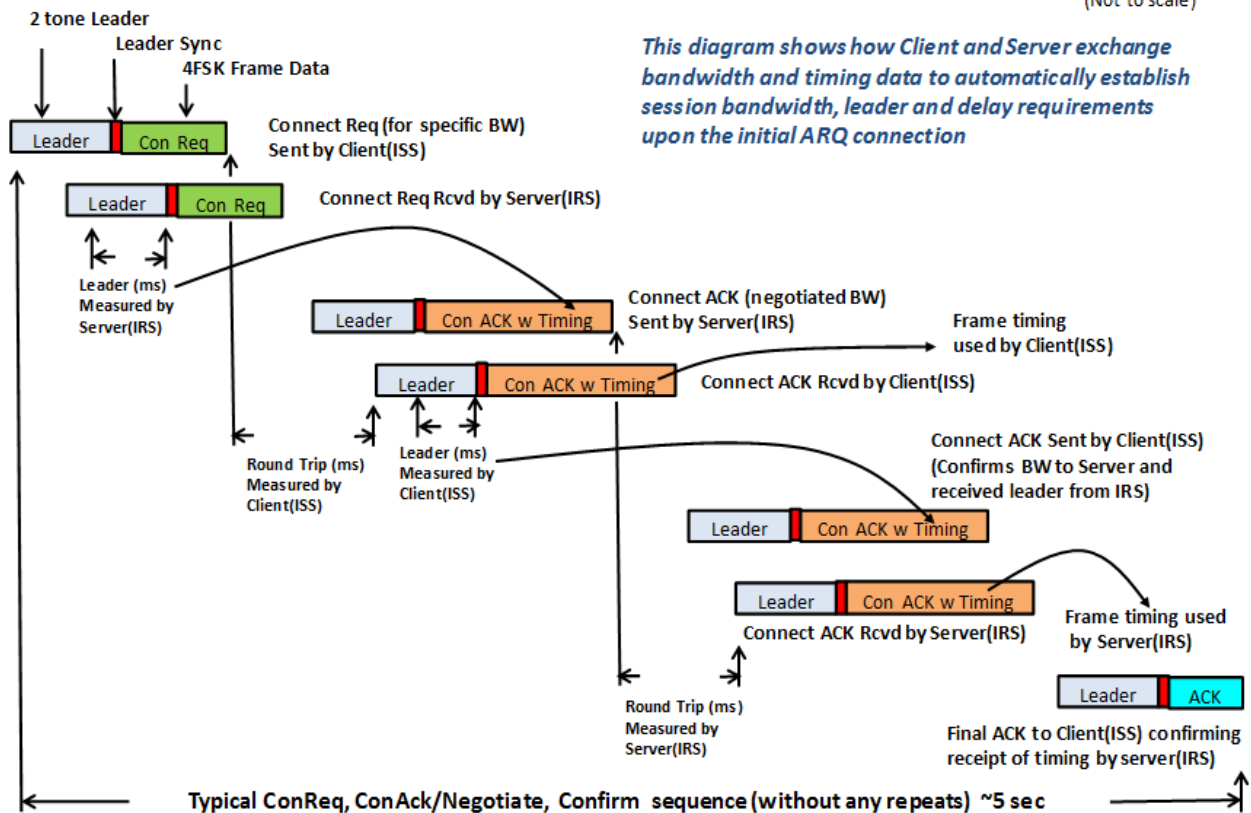

Fig D-1 Simplified ARQ Bandwidth Negotiation & Timing Exchange

Ending a connected session

- 1.5 At any time during a connected session either the IRS or the ISS can end a session by sending a disconnect request (DISC). The DISC command is sent either by the ISS or in place of a normal ACK or NAK by the IRS. When received the receiving station sends an END command followed by an ID command and immediately goes to the DISC state. When in the DISC state if another DISC command is received *that matches the session ID of the previous connected session* it replies with an END (using the previous connected session's Session ID). This accommodates the case where the END replying to a DISC command was missed by the station sending the DISC command.
- 1.6 If the station sending the DISC command receives an END command it goes to the DISC state and the session is ended. If the station sending a DISC command does not receive an END command within the session timeout parameter it sends an ID command and goes to the DISC state and the session is ended.
- 1.7 If during a connected session either the IRS or the ISS does NOT receive a properly decoded command or properly decoded (no CRC error) data frame within the session

timeout parameter it should send an ID command followed by a DISC command and immediately go to the DISC state. (session timeout)

2.0 Normal ARQ data exchange when connected

- 2.1 ARQ Data is sent when connected and by the ISS (Information Sending Station). The ISS sends data plus data byte count using FEC (forward error correction e.g. Reed Solomon encoding) with strong 16 bit CRC parity on the data and data byte count. When using multiple carriers each carrier has its own byte count and CRC. The IRS decodes the data keeping and assembling all carriers (for multiple carrier data modes) that have the correct CRC.
- 2.2 NAK replies. If *all* the carriers of a frame have not been decoded (including any correct decoding of previous frame transmission) the IRS responds with a NAK command. This command also contains a 5 bit quality field that indicates the constellation quality (nPSK or nFSK) as received by the IRS to aid the ISS in determining if a slower more robust data mode is optimum (higher net throughput).
- 2.3 ACK replies. If all the carriers have been decoded (including correct decoding of previous frame transmissions) the IRS responds with an ACK command. This command also contains a 5 bit quality field that indicates the constellation quality as received by the IRS to aid the ISS in determining if a faster less robust data mode is optimum (higher net throughput). When the ISS receives an ACK command it toggles the data frame type (Even or Odd) and starts sending the next data frame. If the ISS misses an ACK frame from the IRS it will repeat the last frame (even or odd) to the IRS. If the IRS receives the same type data frame (even or odd) that it previously ACKed it repeats the ACK and ignores the data (the data has already been processed to the Host's incoming queue).
- 2.4 Missed ACK or NAK commands. If the ISS fails to receive a reply from the IRS (either due to propagation to the ISS or the failure of the IRS to detect the start of a frame) the ISS assumes the frame failed and repeats the frame. The Even/Odd toggling of sequential data frames insures this cannot cause a duplicate of a data frame if the ISS failed to receive the IRS's ACK.

3.0 Transition from ISS to IRS or IRS to ISS

- 3.1 The ISS is the master of frame timing. When the ISS has exhausted all data to be sent (e.g. the IRS has ACK all data frames sent) it sends an IDLE command to indicate it has exhausted all ISS queued data. The IDLE command does not initiate a transition from the ISS to the IRS state but indicates to the IRS that all data has been sent. If further data is generated at the ISS the ISS will resume sending data frames upon reception of an ACK from the IRS. If the IRS has no data to send it responds to the IDLE with a normal ACK command and the sessions continues in this IDLE ACK exchange until data is available at either the IRS or ISS or a session timeout occurs.
- 3.2 If the IRS has data to send and receives an IDLE command it sends a BREAK frame to the ISS. This BREAK frame is repeated by the IRS (the ONLY time the IRS ever repeats a frame). The timing used for this BREAK repeat (and the similar IDLE repeats of the ISS) is set to insure no synchronization problems due to simultaneous transmission.

- 3.3 If the IRS has just sent a BREAK command and receives an ACK it immediately becomes the new ISS.
- 3.4 If the ISS has sent an IDLE command and receives a BREAK it becomes the new IRS but cannot send a BREAK until it receives an IDLE or DATA from the new ISS.
- 3.5 At any time during a data transmission by the ISS the IRS may send a BREAK in place of a normal ACK/NAK response. This starts the following Changeover sequence: The ISS upon reception of the BREAK sends an immediate IDLE (even if it has data to send) and enters the IDLE state. If a BREAK is then received by the ISS it becomes the new IRS as controlled by rule 3.2 above.
- 4.0 ID Frames. The ISS can send an ID frame at any time during a data transmission. This frame contains the call sign of the sending station and the optional grid square (4, 6 or 8 character) location. The ID frame is not ACKed by the other station and is meant to ID the sending station to any station monitoring the connected session. Normally the ID frame is sent every 10 minutes by the transmitting station. The ID frame is also sent at the end of a session as described in rules 2.1 through 2.3 above.

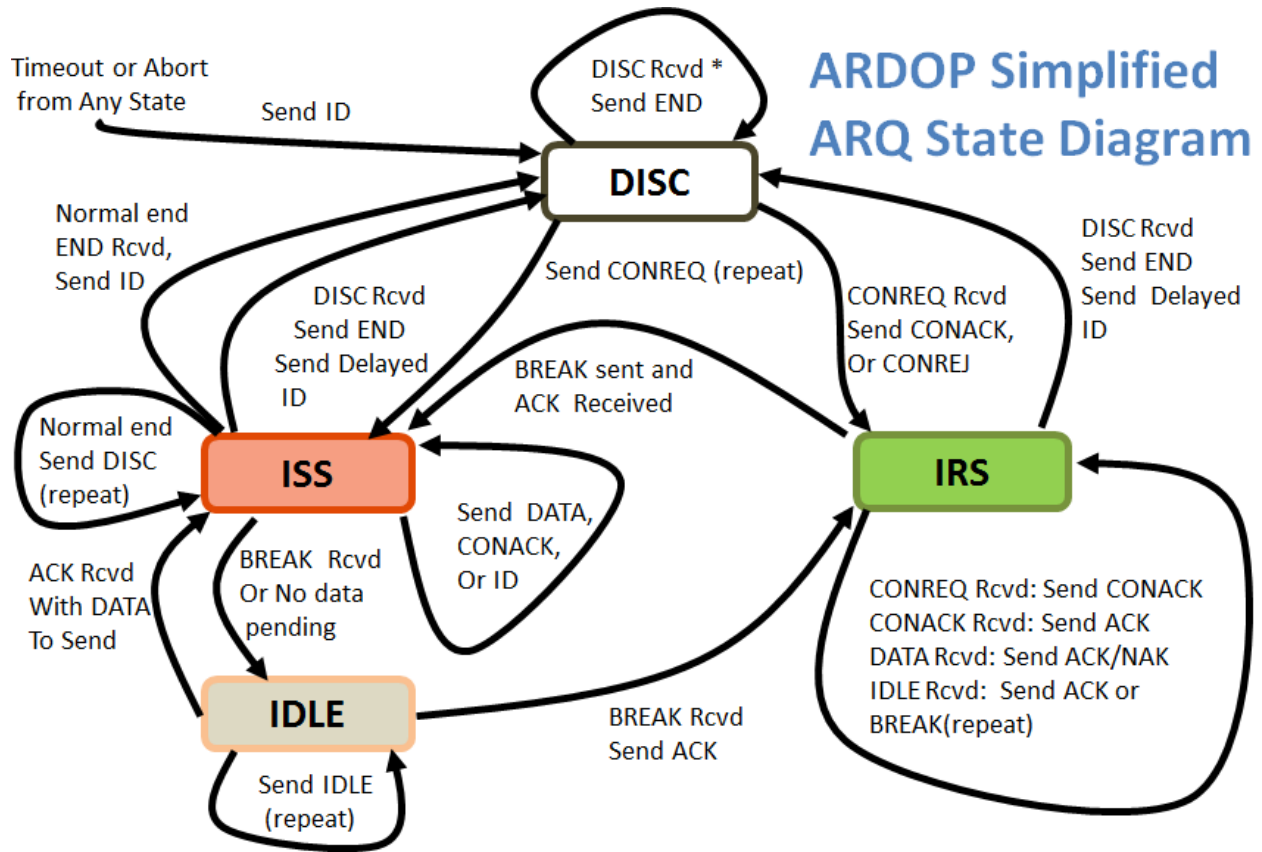

* Session ID must match previous session ID

Rev. KN6KB 6/2/2015

Fig D-2 Simplified ARDOP ARQ State Diagram

FEC SESSION RULES:

FEC sessions are between a sending station and 1 or more receiving stations (multicast). FEC sessions are simpler than ARQ connections and use a combination of Forward Error Correcting codes and optional repeating of frames to improve the likelihood of error-free reception by the multiple receiving stations. Since there is no active back channel (no ACKs/NAKs) with FEC sessions there can be no guarantee of error free data delivery. The sending station may select to repeat the data from 0 (no repeats) to 5 repeats. If any one of the repeated frames is received correctly by the FEC receiving station the result will be error free. Duplicate data from FEC repeats is not passed by the FEC receiving station to the Host.

- 1.0 Starting a FEC session. (Both FEC sending station and the FEC receiving station(s) are assumed to be on line (“sound cards” sampling) and in the DISC state. The Sending station normally begins a FEC session with an optional ID frame (the same as used in ARQ sessions) and then sends data frames using the sending stations selected bandwidth (200, 500, 1000, or 2000 Hz and Data mode (4PSK, 8PSK or 4, 8 or 16FSK). In an FEC session the most robust data modes (usually nFSK) are often used to improve robustness. Since there is no “back channel” there is no “gear shifting” to increase net throughput or change robustness modes. Repeats improve the likelihood of correct reception but at the expense of reduced net throughput. After each data transmission (or repeated group if using repeats) the FEC sending station toggles the Odd/Even frame type. If the stations sending FEC data sends for more than 10 minutes an automatic ID frame is inserted (for legal ID) this is identified as an ID frame and transferred to the host by receiving station. The host can choose to display or ignore the ID data. When all data (including repeats) is sent the FEC Sending station sends returns to the DISC state.
- 2.0 Receiving FEC data. When a station in the DISC state detects a Data frame it goes to the FEC Rcv state and begins decoding FEC data. If the sending station is using repeated FEC frames the receiving station waits until it has received a perfect frame (no CRC error) and then passes that frame to the Host as error free FEC data. If no error free data is received before the FEC sending station toggles the FEC Data Odd/Even frame type the FEC Receiving station passes any received data (with errors) to the host flagging it as “containing errors”. The host can then either display the data in a distinctive way (e.g. RED or strikethrough text) or simply ignore the data. After each received frame the FEC receiving station returns to the DISC state.

ARDOP Simplified FEC State Diagram

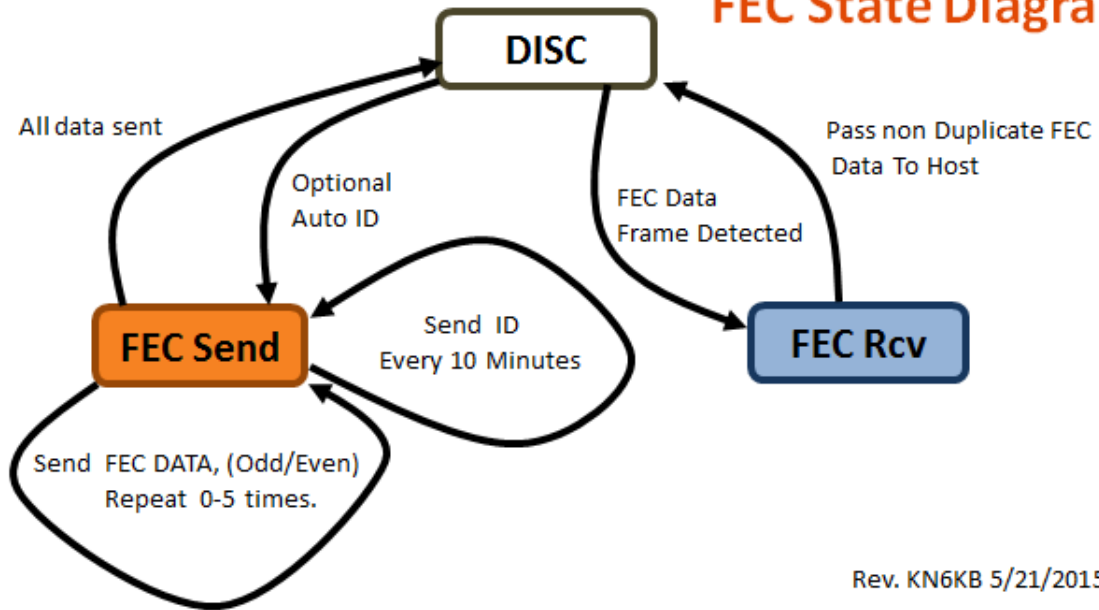

Fig D-3 Simplified ARDOP FEC State Diagram